



A/B WALLMOUNT SPEAKER, WOODEN HOUSING

WWC6TABX/EN



The WWC series is a combination of modern design, high quality sound performance, and an ideal voice alarm speaker for fire alarm and detection systems. It contains one 3,5" speaker driver with 1 x 6W transformer.



EN54-24:2008 0905-CPR-00607 TYPE A

● Standard	Compliant to EN54-24
● Electrical	
Rated power, Watts	2 x (6)
Tappings 100 Volt line, Watts	2 x (6/3/1.5/0.75/0.25)
Transformer Impedance, Ohms 100 Volt	2 x (1.67k/3.33k/6.66k/13.3k/40k)
Tappings 70.7 Volt line, Watts	2 x (3/1.5/0.75/0.375/0.125)
Driver impedance, Ohms	2 x (8)
Effective Frequency Range, Hz (BSEN60268-5)	200-20,000
S.P.L. @ 1 m, 1 Watt, dB, Octave, 100 Hz-10 kHz	95
S.P.L. @ 1 m, Full power, dB, Octave, 100 Hz-10 kHz	103
S.P.L. @ 4 m, 1 Watt, dB, 1/3 Octave, 100 Hz-10 kHz	82
S.P.L. @ 4 m, Full power, dB, 1/3 Octave, 100 Hz-10 kHz	89
Dispersion at 1k/2k Hz, Degrees	149/100 Horizontal 104/56 Vertical
● Environmental	
IP-rating	21
Min/Max amb temp	-10°C to 55°C
Relative humidity	≤95%
● Mechanical	
Dimensions, Front & Depth, mm	255 x 196 x 82
Net weight, kg	2.29
Colour (Unless Specified)	White, RAL9016
Material	Wooden, White PVC Finish, Steel
Mounting	Wall Mounting
Safety	With Plastic Terminal and without Fuse



ATEIS Europe B.V.
Celsiusstraat 1, 2652 XN Lansingerland, Netherlands
Phone +31 (0)10 208 86 90, www.ateis-europe.com, info@ateis-europe.com



INSTALLATION GUIDE

WWC6TABX/EN

EN54-24:2008
0905-CPR-00607
TYPE A

With Transformer:

100V/70V line

	White wire plus tapping					Black
100V	0.25W	0.75W	1.5W	3W	6W	COM
70V	0.125W	0.375W	0.75W	1.5W	3W	COM
IMP.(Ω)	40k	13.3k	6.66k	3.33k	1.67k	

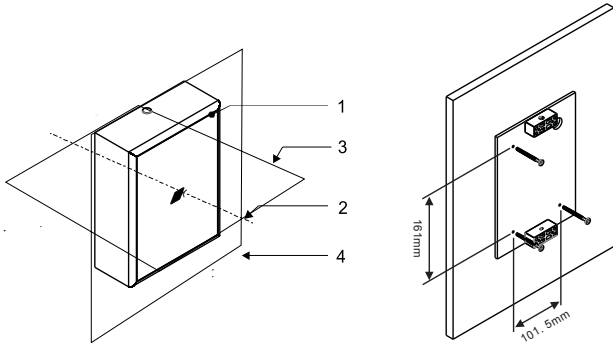
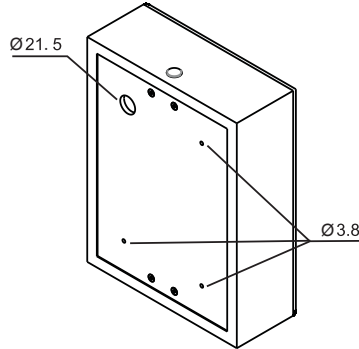
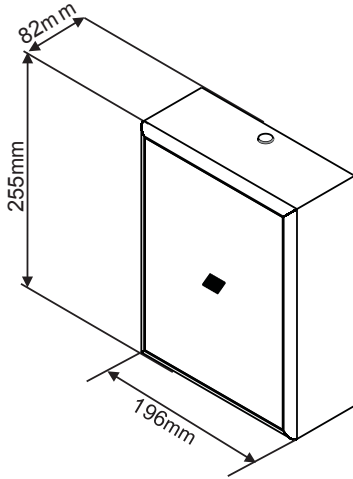

1. Loudspeaker enclosure
2. Reference axis
3. Horizontal plane
4. Reference plane

1) On selecting the chosen position for the loudspeaker (it can be mounted vertically or horizontally) use a spirit level to ensure that it is level. Offer the speaker to the wall or ceiling and mark through the mounting holes, as shown on the drawing to the top, the position required for drilling. Drill 3 holes according to the dimension on the draw.

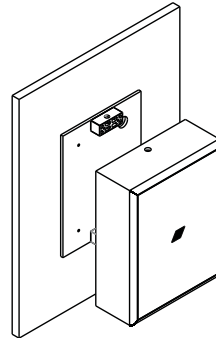

2) Cabling can now take place, connect the 100 volt line supply to your required volume as shown on the circuit diagram.

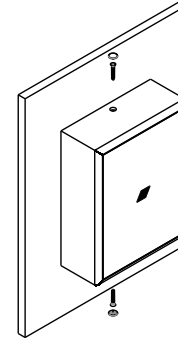

3) Align the holes on the wooden frame to the holes on the plastic blocks.

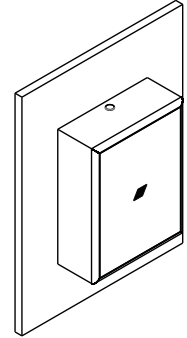

4) Lock the wooden frame and plastic block together with the screws in the speaker enclosure, and using the plastic caps to cover the screws.

Technical Specifications

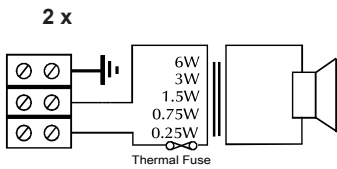

Circuit Diagram

WWC6TABX/EN

X: Represent Plastic Terminal and without Fuse

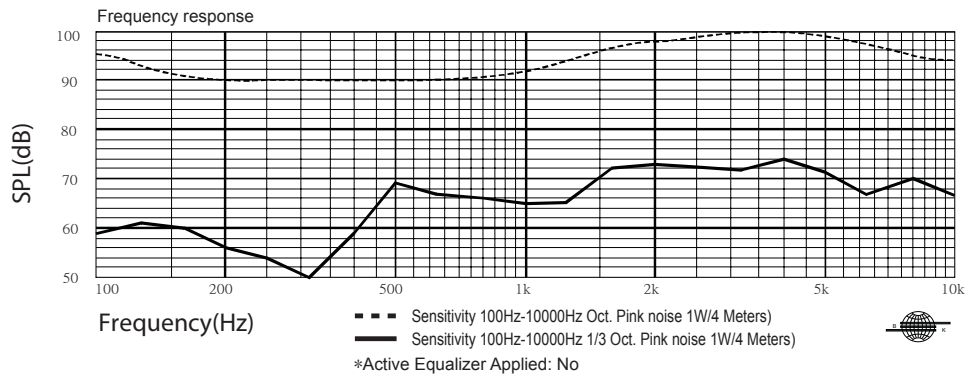

Disclaimer: We reserve the right of changes and errors.



ATEIS Europe B.V.
 Celsiusstraat 1, 2652 XN Lansingerland, Netherlands
 Phone +31 (0)10 208 86 90, www.ateis-europe.com, info@ateis-europe.com

